

DC-TO-DC CONVERTER

MODEL 1723-24-48-6

USER'S INFORMATION



MODEL 1723-24-48-6
DC-TO-DC CONVERTER
USER'S INFORMATION

All information contained in this document is the property of Wilmore Electronics Company, Inc. The providing of this document to any person or organization external to Wilmore shall in no way be construed as a license or as permission to use this information for any purpose other than to facilitate the use and maintenance of Wilmore equipment.

WILMORE ELECTRONICS COMPANY
607 U.S. 70A East
P.O. Box 1329
Hillsborough, N.C. 27278

Telephone: (919) 732-9351
Fax: (919) 732-9359
www.wilmoreelectronics.com

CAUTION!

To avoid equipment damage during installation...

- 1) Prior to installing the converter, verify that its front-panel input power switch (a “rocker-arm” circuit breaker) is in the OFF position, indicated by a wedge-shaped section of the rocker arm protruding from the front panel and exposing white plastic in the rocker assembly. If the converter does not appear to be turned off, push against the word “OFF” printed on the switch face to expose the white plastic indicator before making any connections to the converter.
- 2) Safe installation practice dictates that the DC input line connections should be de-energized at the DC source prior to connecting to the converter input. Verify that this is the case before making any connections to the converter. Once these input connections are made and the converter’s input power switch has been verified to be in the OFF position, the DC input lines can be energized.

... do not “hot plug” or apply an energized connection to a “turned on” converter.

MODEL 1723 DC-TO-DC POWER CONVERTER

USER'S INFORMATION

TABLE OF CONTENTS

- I. General Description
- II. Installation and Operation
- III. Maintenance Information
- IV. Warranty Statement

I. GENERAL DESCRIPTION

This dc-to-dc power converter provides an isolated and regulated 48-Vdc output from 24-volt station batteries or other widely fluctuating 24-Vdc sources. The input voltage range is 20 to 30Vdc. The maximum rated output current is 6 amperes (continuous duty rating at 70°C ambient temperature and free air convection cooling). The converter output is galvanically isolated from the input source and chassis and, therefore, may be connected as either a positive or a negative output.

This converter is electronically protected against overloads, short circuits, and converter-induced output overvoltages. Recovery to normal operating conditions is automatic upon removal of an overload or short-circuit fault. Following an overvoltage shutdown, input power to the converter must be removed for approximately 30 seconds and then reapplied to resume converter operation. Protection against accidental reversal of the input-voltage polarity during installation is provided by a shunt diode working in conjunction with the front-panel circuit breaker.

The operating efficiency of this converter exceeds 85% for most of the output load range. An approximation of input current for a specific input voltage and output load current can be determined as follows:*

$$\text{Input Current} = \frac{(\text{Output Voltage}) (\text{Output Current})}{(0.85) (\text{Input Voltage})}$$

Note that this converter is a constant-output-power device, i.e., with a constant load, the input current and input voltage are inversely proportional. This means that the maximum input current is drawn at the minimum input voltage.

*This approximation applies for output load currents equal to or greater than 20% of maximum rated load current. For loads less than 20% of the maximum rating, linearly decrease the input current from its calculated value at 20% load to 200 milliamperes at no load.

II. INSTALLATION AND OPERATION

Connection and operation of the Model 1723-24-48-6 converters are almost entirely self-explanatory from the front- and rear-panel markings on each unit.

A combination circuit breaker and ON/OFF switch is provided on the front panel for input power. Its rocker handle is flush with the front panel while in the ON position to guard against unintentionally turning the circuit breaker OFF through incidental contact.

All electrical connections to the converter are located on the rear panel. **CAUTION: Always verify that the input power source has been turned OFF before inserting or removing input/output wiring or connectors.** Power connections are made via two-part (i.e. header and plug) connectors. Input and output cabling can be connected to the converter without separating the plug from the header. Alternately, the plug may be removed from the converter by disengaging its mounting-flange screws, and the cabling can be connected to the plug prior to re-engaging it with the header on the converter's rear panel (be sure to re-engage the mounting-flange screws as well). The positive and negative terminals on each power connector are clearly marked, and deliberate caution should be exercised to avoid polarity mistakes. To connect the power cables, simply strip 3/8" – 1/2" from one end of each cable and insert into the appropriate connector wire clamp. Tighten the wire-clamp screw securely and, if using stranded wire, check to make sure that all wire strands have been captured by the wire clamp. Both the input and the output of the converter are dc-isolated from the chassis and from each other. A connection to chassis ground is provided that accepts lugs for use with #8 hardware.

It is suggested that #8 AWG cables be used to connect the converter to its battery source and that #10 AWG cables be used to connect to its 48-volt load. These cables should be kept as short as possible, and if their length must exceed 10 feet, it may be desirable that larger cable be used.

See Figure 1 for additional information.

Good installation practice for power conversion equipment dictates that an input fuse or circuit breaker should be located at the power-source end of the cables feeding the equipment. The type and rating of such devices are largely dependent on local and/or national codes and installation variables such as cable routing and wire gauge. Wilmore cannot anticipate these variables and consequently does not recommend specific fuse or circuit breaker values. However, it is important to note a few operating characteristics of this unit that may affect an installer's choice of protection devices.

1) As mentioned previously, this unit is a constant-power device; that is, it draws its maximum input current at its minimum input voltage.

2) As with essentially all electronic equipment with significant input capacitance, the unit will draw an initial peak current many times its normal operating current for a very brief period (a few milliseconds or so) when power is initially applied. Consequently, instantaneous-trip circuit breakers or non-time-delay fuses may be activated by normal power-up events and are not recommended.

3) Following the brief capacitor-charging current described above, the unit will exhibit a “soft-start” characteristic that limits its input current to approximately that of its full load current (see Section I for specific load current information) as the circuit reaches its normal operating mode. Consequently, and even though the user’s application may only require a fraction of the unit’s power rating, the input circuit breaker or fuse must be sized to accommodate the full-load input current to avoid nuisance tripping.

FIGURE 1. FRONT & REAR PANELS (shown without plugs attached)

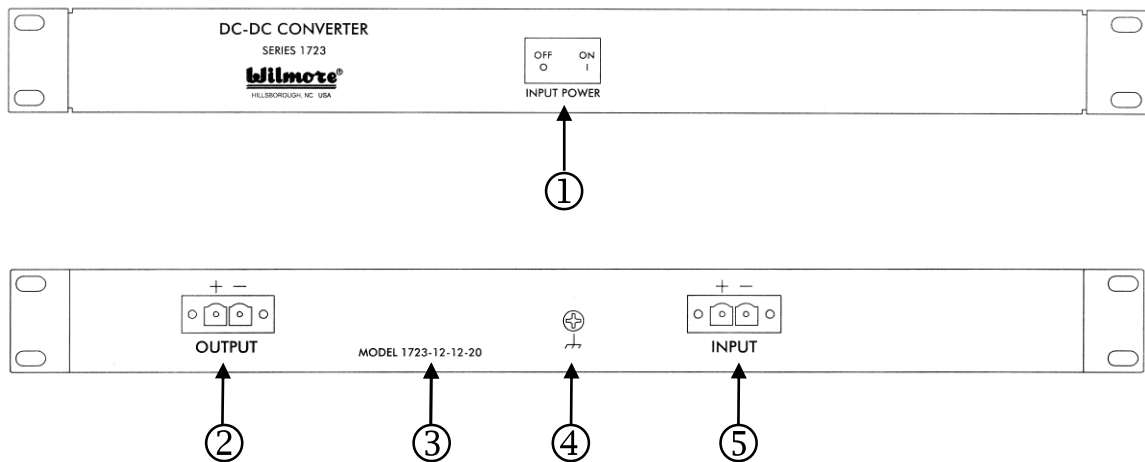

- ① **DC INPUT CIRCUIT BREAKER:** This is a combination DC input switch and circuit breaker, provided in the positive (+) input line.
- ② **DC OUTPUT CONNECTOR:** Connections for DC output power are provided via a two-part (plug and header) connector.
- ③ **MODEL NUMBER:** This is the complete model number of the inverter, including any standard or special factory-assigned modification codes.
- ④ **CHASSIS GROUND TERMINAL:** Connection to chassis ground is provided for use with #8 hardware.
- ⑤ **DC INPUT CONNECTOR:** Connections for DC input power are provided via a two-part (plug and header) connector.

III. MAINTENANCE INFORMATION

Other than preventing dust and debris accumulation on internal components and external surfaces of the converter, no periodic maintenance should be required.

A damaged or malfunctioning unit should be returned to Wilmore for repair. Multiple-component cascade failures in power conversion circuitry can greatly complicate trouble-shooting procedures, and factory technicians familiar with the circuitry can locate the problem quickly, explore adjacent circuitry for stressed or damaged components, and subject the converter to a thorough retest.

Wilmore maintains a **Return Material Authorization** system in order to efficiently track your inbound shipment and expedite its repair and return to you. Before shipping material for repair to Wilmore, please call (919) 732-9351 or email info@wilmoreelectronics.com and request a **RMA Number** for your shipment. If possible, please provide the complete model number of the equipment, its serial number, and a brief description of the problem. Place this **RMA Number** on the outside of the package and ship prepaid to:

WILMORE ELECTRONICS CO., INC.

607 U.S. 70A East

P.O. Box 1329

Hillsborough, NC 27278

LIMITED WARRANTY

Wilmore Electronics Company, Inc. warrants this product to be free from defects in material and workmanship for one (1) year after delivery to the original purchaser. During this period, a defective product for which an authorization to return the product has been given, shall be returned to Wilmore freight prepaid. The products will be repaired, replaced, or credit allowed only if the defect, after examination by Wilmore, is determined to be a defect in material or workmanship. If this returned product is determined by Wilmore to have suffered from user misuse or abuse or to have been opened or modified without written instructions from Wilmore, or if the date of receipt of a request for return authorization exceeds the 1-year warranty period, the warranty is null and void. In such cases, Wilmore will determine the cost of repair, quote this price to the purchaser, and continue as advised by the purchaser.

The sole obligation of Wilmore and the purchaser's exclusive remedy under this or any other warranty, expressed or implied, is the repair or replacement of a defective product as provided above, or the issuance of credit in an amount not to exceed the contract price for the product deemed to be defective. Wilmore makes no warranty of merchantability or fitness for a particular use. Wilmore shall not be responsible for incidental or consequential damage, whether or not foreseeable, caused by defects in this product. There are no other warranties which shall extend the description above.